

Three-phase motors Aluminium housing

Type		SA3 132S6-405 AA
Design output	[kW]	3.0
Design torque	[Nm]	29.8
Class IE		IE3-85.6%
Efficiency determination		EN 60034-2-1
Duty type		S1
Design frequency	[Hz]	50
Design speed	[rpm]	960
Voltage	[V]	230/400
Connection		D / Y
Current	[A]	11.90 / 6.84
Relative pull-in current		6.8
Relative starting torque		2.4
Relative pull-out torque		3.0
Efficiency 100 / 75 / 50 %	[%]	85.6 / 85.0 / 83.6
Power factor		0.74
Th. cl.		155 (F/B)
Coolant temperature	[°C]	-20°C ... +40°C
Altitude above sea level	[m]	1000
Degree of protection IP		IP 55
Moment of inertia	[kgm ²]	0.02971
Motor weight	[kg]	41.0
Bearing D-side		6308 2RS/C3
Bearing N-side		6308 2RS/C3
Relubrication interval	[h]	-
Grease type		-
Grease amount	[g]	-
A-sound pressure level L _{WA}	[dB]	78.0
Options:		
Terminal box		Standard
Position of terminal box		On the top
Cable gland		Brass cable glands
Position of cable entry		Right
Shaft		Standard
Bearing		Easy bearing arrangement
Special information about the bearing		SKF bearing
Winding protection		-
Limit values to vibration velocity		Class A
Balancing		with half key
Colour		RAL 7030
Delivery conditions and/or official regulations		IEC / EN 60034-1

Data sheet

IM B3



IM B35

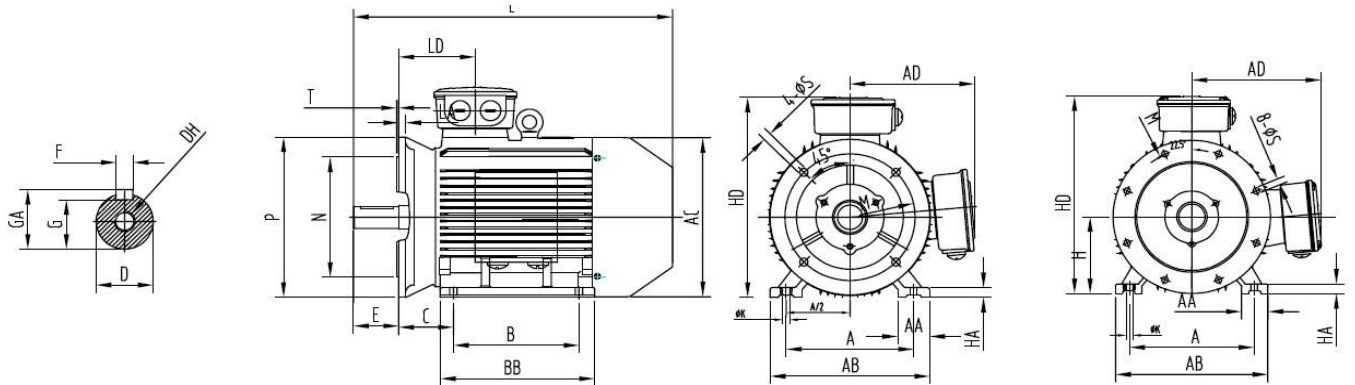

IM B5



A	B	B ¹	C	D	E	F	G	H	K	DH	GA	AA	AB
216	140	-	89	38	80	10	33	132	15	M12x28	41	58	270

AC	AD	HA	HD	BB	LD	L	M	N	P	S	T	LA
265	193	16	325	176	94	455	265	230	300	4 x ϕ 14.5	4	14

Data sheet

IM B14



IM B34



A	B	B ¹	C	D	E	F	G	H	K	DH	GA	AA	AB
216	140	-	89	38	80	10	33	132	15	M12x28	41	58	270

	AC	AD	HA	HD	BB	LD	L	M	N	P	S	T	LA
B14C	265	193	16	325	176	94	455	165	130	200	4 x M10	3.5	14
B14B	265	193	16	325	176	94	455	215	180	250	4 x M12	4	14